

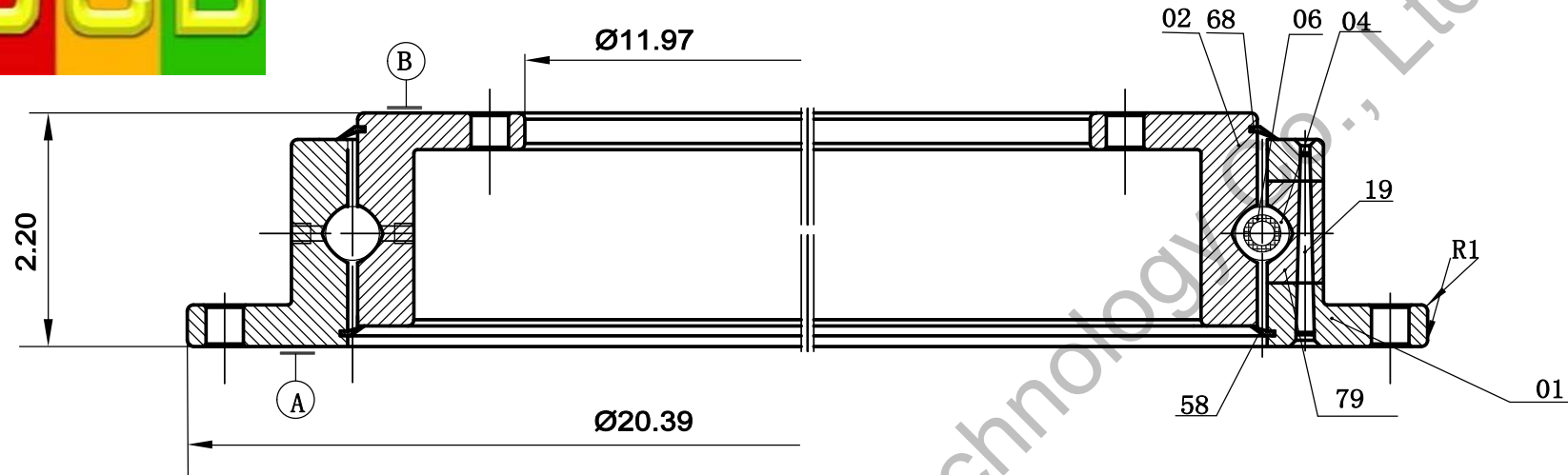

A-A



Remark:

1. Luoyang JCB Bearing Technology Co., Ltd is a technical Inc, specialize in designing and manufacturing slewing ring bearing, we can design and manufacture all kinds of slewing bearing according to client's requirement.
2. This drawing is reference for user, if you need formal drawing, please contact with us sales@jcb-bearing.com, the official drawing will be submitted after order confirmation.

Contact information

Company Address : No.3 Lianmeng road, Luoyang, Henan, China.

Postal code : 471003

Phone : 86-379-68611678 Fax : 86-379-68611679

E-mail: sales@jcb-bearing.com

Reserved E-mail: sales@slewing-ring-bearings.com

Website: www.jcb-bearing.com

www.slewing-ring-bearings.com



# Series 2100

## L6-16P9Z

			weight(lbs)
S			52

Luoyang JCB Bearing Technology Co., Ltd